



THIS IS AN IMPORTANT DOCUMENT PLEASE READ AND KEEP WITH YOUR RECEIPT

Product After Care

To prolong the life of your product, some additional minor maintenance and aftercare will be required. Warm soapy water is recommended to clean the product, steel components may corrode if not treated (For guidance contact manufacturer), an all purpose water sealant should be used to protect stone table tops, and enclosed touch up paint can repair minor defects. Throughout the winter months, we recommend bringing indoors where possible or using a furniture cover.

General Warranty Conditions

The warranty applies to the original purchaser from the date of purchase and covers manufacturing faults and defects only. If an item should fail as a result of a manufacturing fault or defect under normal domestic use, the manufacturer at their discretion will repair, refinish or replace the failed item. The manufacturer reserves the right to substitute failed items with a similar product should the model or colour no longer be available. Any replacement will be for the failed item only not a complete set. The original warranty period is not extended in the event of a repair, refinish or replacement. In the event of a failure, it is the customer's responsibility to return the item to the store of purchase along with a copy of the receipt. Warranty specifically excludes general wear and tear, rusting of steel components and parts, corrosion, commercial use and damage caused as a result of failure to observe reasonable care, maintenance and assembly instructions for both furniture and hardware.

Necessary Tools

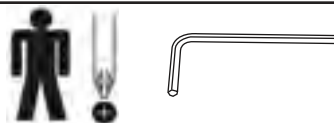









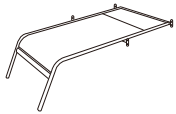

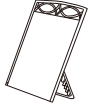

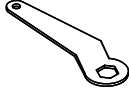

Please check the pack contents before attempting to assemble this product. A full checklist of Components is given in this leaflet. If any components are missing, please contact the retailer from whom you bought this product

The fittings pack contains **SMALL ITEMS** which should be **KEPT AWAY FROM YOUNG CHILDREN.**

Read this leaflet in full before commencing assembly.

PARTS LIST

SEAT	A		1	PLASTIC BOLT CAP (M6)	L		10
BACK	B		1	PLASTIC NUT CAP (M6)	J		2
LEFT LEG	C		1	PLASTIC WASHER (T=6mm)	K		2
RIGHT LEG	D		1	ALLEN WRENCH	M		1
BOLT (M6X25L)	E		8	HEX WRENCH	N		1
BOLT (M6X60L)	F		2	HEADREST	P		1
METAL WASHER (Φ6.5)	G		10	TOUCH UP PAINT			1
NUT(M6)	H		2				

Step 1

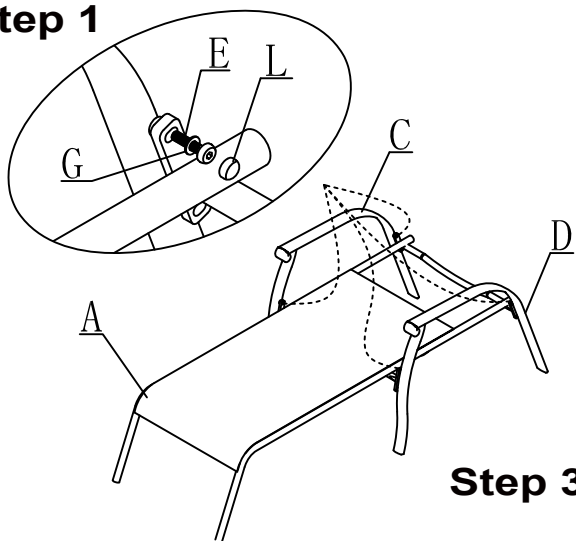

Step 2

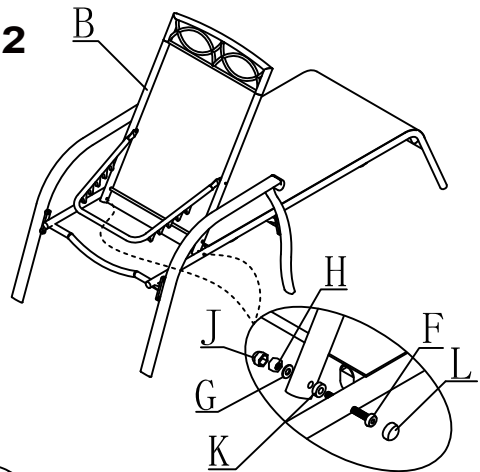

Step 3

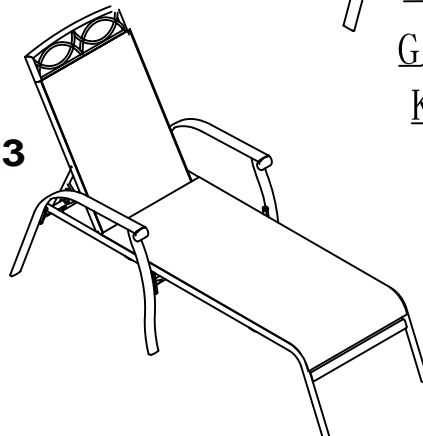

PLEASE ENSURE ALL FIXINGS ARE LEFT LOOSE DURING ASSEMBLY, BUT ARE SECURELY TIGHTENED UPON COMPLETION.